

Receiver

From

Society
Reference
Address
Phone
Fax
E-mail

Item n° :

60194267

Model :

FEKA FXC 20.22 T-NA Ex

Type of installation :

Wet - Pump only

Pump data

Free passage : 50 mm
Max. immersion depth : 20 m
Min. fluid temperature : 0 °C
Max. fluid temperature : 50 °C

Requested data

Flow :
Head :
Fluid : Water
Fluid Temperature : 20 °C
Density : 998,3 kg/m³
Kinematic viscosity : 1,005 mm²/s
Vapor pressure : 2,34 kPa

Hydraulic data (duty point)

Flow :
Head :

Materials

Handle : Cast iron (EN GJL 200)
Pump body / motor : Cast iron (EN GJL 200)
Impeller : Cast iron (EN GJL 250)
Mechanical seal pump side : SiC-SiC/SiC-C
Mechanical seal motor side : SiC/Carbon
OR ring : NBR
Motor shaft : Stainless Steel AISI 304

Curve tolerance according to ISO 9906

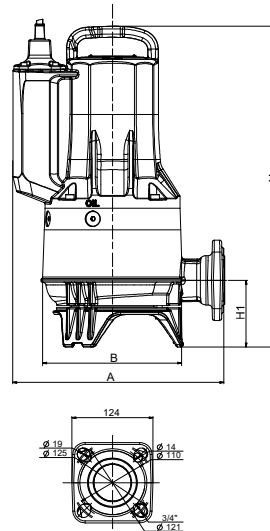
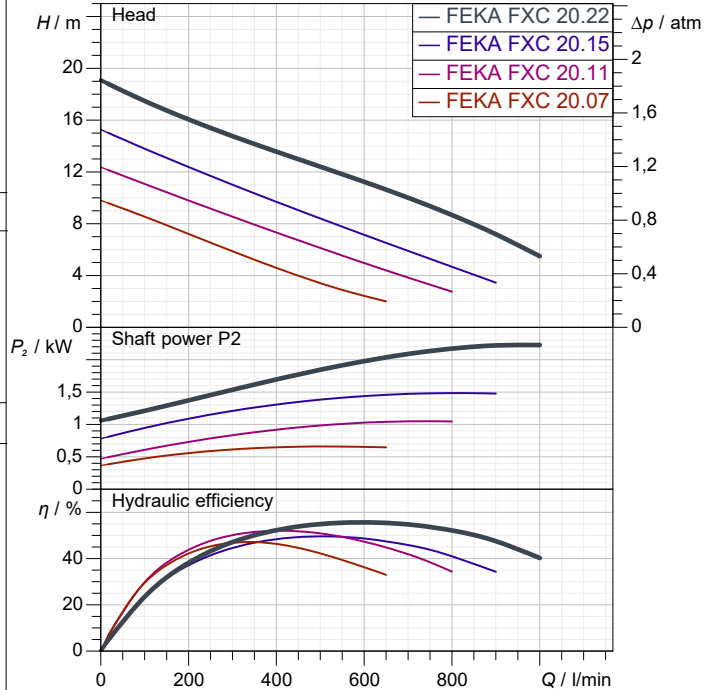

Motor data

Motor brand : DAB
Nominal power P₂ : 2,2 kW
Rated speed : 2.870 1/min
Rated voltage : 3~ 400 V
Nominal current : 4,9 A
Degree of protection : IP 68

Weight : 43 kg

Accessory weight :

Dimensions in mm

A	322				
B	218				
DN1	50				
GAS	Rp 2"				
H	512				
H1	103				

Pump connection

Suction side : --
Discharge side : Rp 2" - DN 50 PN10/6

Receiver

From

Society
Reference
Address
Phone
Fax
E-mail

FEKA FXC 20.22 T-NA Ex

Curve tolerance according to ISO 9906

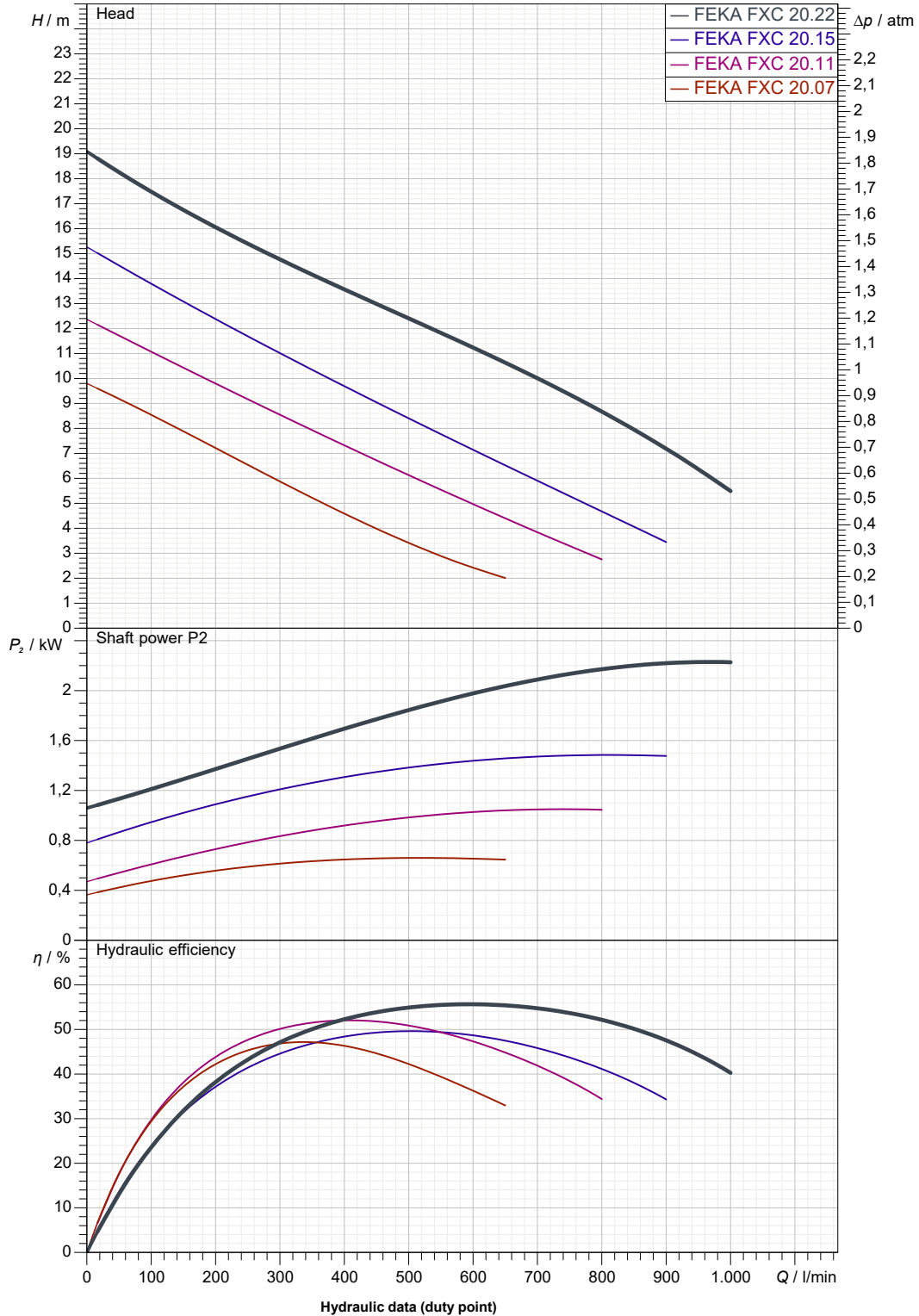

Suction side :

Discharge side :
Rp 2" - DN 50 PN10/6
--

Flow :

Head :

Rated speed :
2.870 1/min

MAIN_PROJECT_TITLE

BUSINESS_PROCESS_ID

OWNER_

ISSUE_DATE
2020-12-09



DIMENSIONAL DRAWING

2020-12-09

Page 3 / 3

DAB PUMPS S.p.A.
Via Marco Polo, 14 - 35035 Mestrino (PD), Italy
Tel. +39 049 5125000 - Fax +39 049 5125950
www.dabpumps.com

Receiver

From

Society
Reference
Address
Phone
Fax
E-mail

FEKA FXC 20.22 T-NA Ex

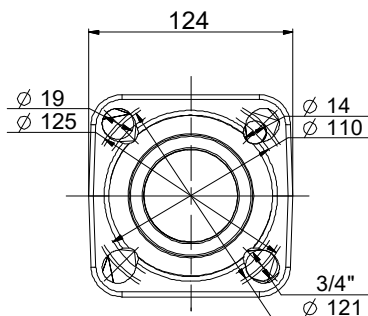
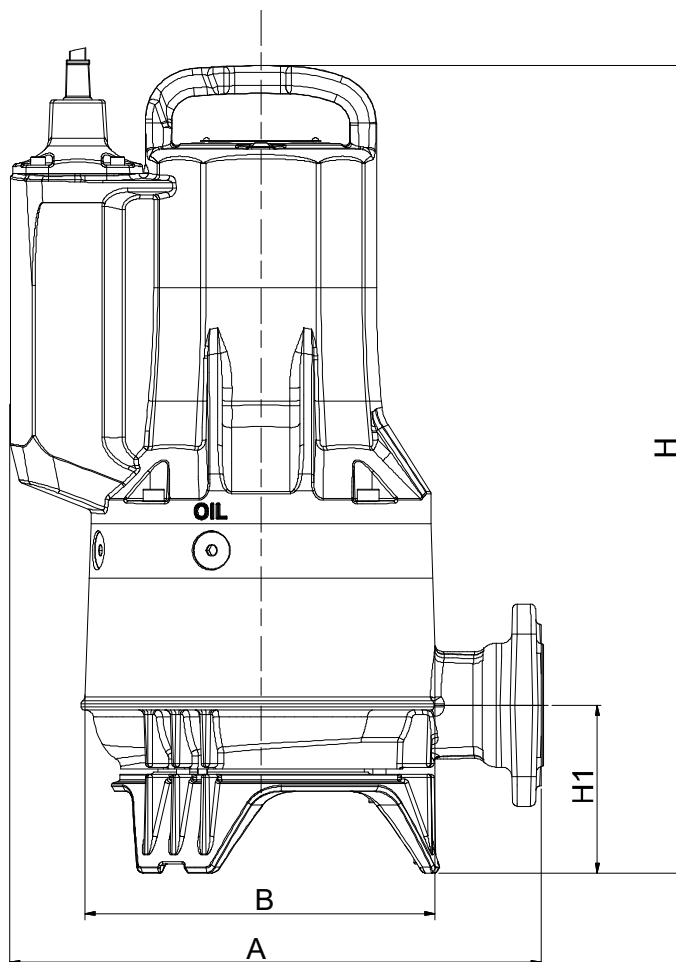

Dimensions in mm

Pump connection

1
2
3
4
5
6
7
8
9
10
11
12

A	322
B	218
DN1	50
GAS	Rp 2"
H	512
H1	103

Suction
Discharge
Rp 2" - DN 50 PN10/6
--

MAIN_PROJECT_TITLE

BUSINESS_PROCESS_ID

OWNER

ISSUE_DATE

2020-12-09